

Natural Language Processing Large Language Models Usage and Evaluation Patterns

Felipe Bravo-Marquez

December 13, 2023

Introduction

- Since the inception of Large Language Models, various patterns of use and evaluation of this technology have emerged.
- In this talk, we will try to organize these patterns and give a general overview of them.



Source:

<https://www.masayume.it/img/masayume/Large-Language-Models.jpg>

Recap: What is an LLM

- Large Language Model: An autoregressive Transformer neural network trained on a large corpus (hundreds of billions of tokens) and a large parameter space (billions) to predict the next word from a fixed-size context.
- It is usually later aligned to work as a user assistant using techniques such as Reinforcement Learning From Human Feedback [Ouyang et al., 2022] or supervised fine-tuning.
- Some are private (access via API or web browser): Google Bard, ChatGPT, etc.
- Others are open (model's weights can be downloaded): Llama, LLama2, Falcon, etc.



Zero-shot, One-shot, and Few-shot Learning

The most remarkable feature of these models is their few-shot, one-shot, zero-shot learning capabilities (also known as “in-context-learning”).

The three settings we explore for in-context learning

Zero-shot

```
1 Translate English to French: ← task description
2 cheese => ..... ← prompt
```

One-shot

```
1 Translate English to French: ← task description
2 sea otter => loutre de mer ← example
3 cheese => ..... ← prompt
```

Few-shot

```
Translate English to French: ← task description
1 sea otter => loutre de mer ← examples
2 peppermint => menthe poivrée ←
3 plush girafe => girafe peluche ←
4 cheese => ..... ← prompt
```

Traditional fine-tuning (not used for GPT-3)

Fine-tuning

```
1 sea otter => loutre de mer ← example #1
↓
gradient update
↓
1 peppermint => menthe poivrée ← example #2
↓
gradient update
↓
...
↓
1 plush giraffe => girafe peluche ← example #N
↓
gradient update
↓
1 cheese => ..... ← prompt
```

This means that they can learn new tasks without large amounts of human-annotated data.

Talk Overview

- Despite the recency of this technology, its adoption has been tremendous in many areas.
- Below, we propose a simple categorization of the ways in which LLMs are used and evaluated.
- These patterns will serve as the narrative backbone of this presentation.

Usage Patterns

1. General-domain Assistant
2. Domain-specific Assistant
 - 2.1 Retrieval-augmented generation
 - 2.2 Fine-Tuning
3. LLM-based Applications
 - 3.1 API calls
 - 3.2 Autonomous Agents

Evaluation Patterns

1. Multi-task benchmarks
2. World-knowledge benchmarks
3. Multi-turn benchmarks
4. LLM-as-a-judge

Usage Pattern 1: General-domain Assistant

- In this pattern a user interacts with the LLM providing prompts as input and receiving a text as answer.
- The knowledge the LLM has access is limited to the corpus on which it was trained and the context given in the prompt.

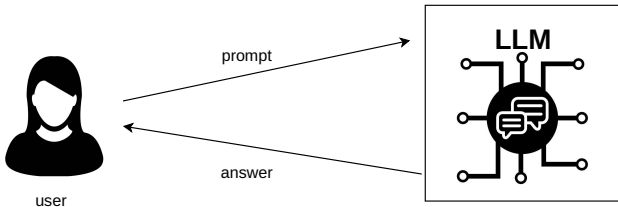

Tasks

LLMs can solve many tasks with this pattern:

- Textual: Language understanding and common sense (e.g., rewriting, summarizing, translating, answering questions)
- Arithmetic: Mathematical reasoning (it can fail in many cases though)
- Visual: Multimodal reasoning involving pictures (GPT-4, Llava, Gemini)
- Symbolic: Structured input such as programming languages

Source:

<https://twitter.com/IntuitMachine/status/1727079666001870877>.

Prompt Engineering: Guiding the Language Model

Prompt engineering, often referred to as “Prompting,” is the discipline of crafting effective prompts to guide the Language Model (LM) towards generating accurate responses. Some common prompting guidelines:

- **Clarity and Conciseness:** Clearly articulate the prompt to minimize ambiguity and ensure that the LM understands the task at hand.
- **Use of Specific Examples:** Provide specific examples within the prompt to give the LM context.
- **Role-Based Prompts:** Incorporate roles into prompts (e.g., a tour guide, a teacher, a doctor, a salesperson).
- **Desired Output Specification:** Specify the desired output format (e.g., JSON, HTML, csv, markdown, latex).

Chain-of-thought Prompting

- Chain-of-thought prompting is a mechanism for inducing multi-step reasoning behavior in large language models.
- In this method, each exemplar in a few-shot prompt is augmented with a connected sequence of thoughts, creating a structured chain of logical steps. [Wei et al., 2022]

Chain-of-thought prompting

Standard Prompting

Model Input

Q: Roger has 5 tennis balls. He buys 2 more cans of tennis balls. Each can has 3 tennis balls. How many tennis balls does he have now?

A: The answer is 11.

Q: The cafeteria had 23 apples. If they used 20 to make lunch and bought 6 more, how many apples do they have?

Model Output

A: The answer is 27. ❌

Chain-of-Thought Prompting

Model Input

Q: Roger has 5 tennis balls. He buys 2 more cans of tennis balls. Each can has 3 tennis balls. How many tennis balls does he have now?

A: Roger started with 5 balls. 2 cans of 3 tennis balls each is 6 tennis balls. $5 + 6 = 11$. The answer is 11.

Q: The cafeteria had 23 apples. If they used 20 to make lunch and bought 6 more, how many apples do they have?

Model Output

A: The cafeteria had 23 apples originally. They used 20 to make lunch. So they had $23 - 20 = 3$. They bought 6 more apples, so they have $3 + 6 = 9$. The answer is 9. ✓

Usage Pattern 2: Domain-specific Assistant

- Idea: Incorporate domain-specific knowledge not covered in training (e.g., recent news, private documents).
- This is very common for companies developing chatbots with private documents or for creating more domain-specific chatbots.
- There are two main patterns to achieve this:
 1. Retrieval-Augmented Generation (Vector Databases)
 2. Fine-Tuning

Usage Pattern 2.1: Retrieval-Augmented Generation

Idea: Incorporate domain-specific knowledge into the prompts using information retrieval and document embeddings (i.e., densely encoded vectors that capture the semantic information of the document). [Lewis et al., 2021].

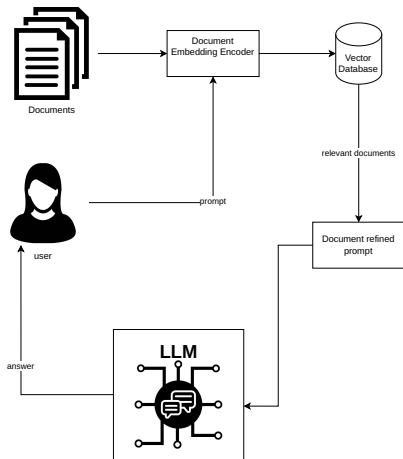

Retrieval-Augmented Generation Process

1. Encode all domain-specific documents using document embeddings and store them in a vector database.
 - OpenAI provides a vectorizer called (text2vec-openai), but there are many open source alternatives.
 - There are also many vector databases available, a popular one is **weaviate**.
2. Encode the prompt with the same vectorizer used to encode documents.
3. Use prompt embedding and the vector database to retrieve relevant documents based on similarity.
4. Create a refined prompt that includes a domain-specific role, the user prompt, and the retrieved documents as contexts.
5. Send the refined prompt to the LLM and return the response to the user.

Usage Pattern 2.2: Fine-Tuning

Idea: Incorporate domain-specific knowledge by fine-tuning a pre-trained LLM with the next-token prediction task over a domain-specific corpus and interact with the resulting LLM.

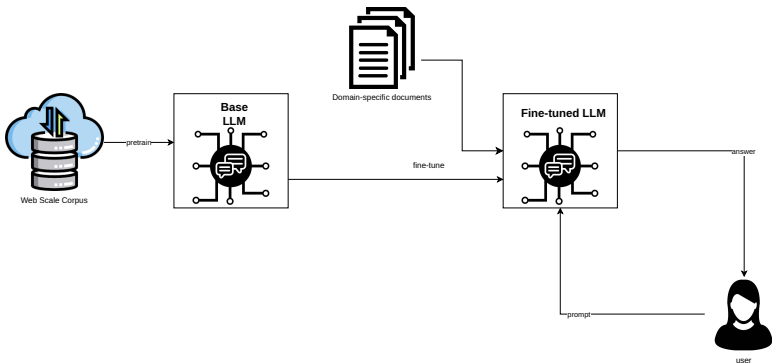

This can be computationally expensive unless some tricks are used.

Instruction Fine-tuning

- A more efficient way to fine-tune Large Language Models is Instruction Fine-Tuning [Chung et al., 2022].
- Idea: instead of fine-tuning the LLM with raw text with next token prediction, train it with pairs of prompts and user-aligned answers.
- Collect examples of (instruction, output) pairs across many tasks and finetune an LM.
- Evaluate on unseen tasks.

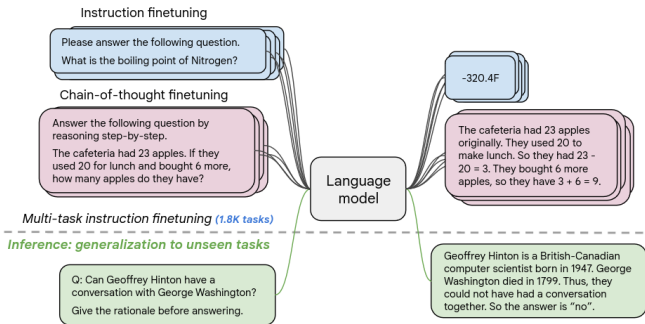

Datasets for Instruction Fine-Tuning

- Alpaca Data: 52k English instruction examples generated using OpenAI's text-davinci-003 with self-instruct.
- Evol-Instruct (Xu et al., April 2023): A rewritten set of 250k English instruction-response pairs based on the Alpaca data
- Vicuna ShareGPT: 70k English conversations shared by users and scraped from ChatGPT.
- Baize data (Xu et al., April 2023)
- databricks-dolly-15k (Conover et al., April 2023)
- OpenAssistant Conversations (Köpf et al., April 2023)
- LIMA data (Zhou et al., May 2023).

source:

<https://nlpnewsletter.substack.com/p/instruction-tuning-vol-2>

Considerations for Instruction Tuning

- **Data Source:** How was the data obtained? Most datasets have been generated using ChatGPT. They may thus inherit biases of the source model or may be noisy.
- **Data Quality:** Was any filtering done to improve the quality of the generated data? In most cases, filtering is based on simple heuristics or a pre-trained model, which can result in noisy data.
- **Domain and Language Coverage:** Most datasets focus on general QA-style in English, but methods can be adapted for other domains or languages.
- **Number of Dialog Turns:** Single-turn datasets include a prompt and response. Consider multi-turn data for training a more conversational model.
- **License Terms:** Data from OpenAI models follows OpenAI terms, restricting use for competing models. Seek datasets with more permissive licenses to avoid legal complications.

source:

<https://nlpnewsletter.substack.com/p/instruction-tuning-vol-2>

Parameter Efficient Fine Tuning (PEFT)

- Traditional model fine-tuning (i.e., adjusting all Transformer weights via backpropagation) is time and resource-intensive.
- Parameter Efficient Fine Tuning (PEFT) are a series of techniques to mitigate this problem.
- The most popular ones are LoRA (Low Rank Adaptation) [Hu et al., 2021] and QLoRA [Dettmers et al., 2023].
- These approaches achieve significant reduction in the number of trainable parameters allowing to perform fine-tuning with affordable hardware.

LoRA

- LoRA is based on the idea of adapters.
- Instead of fine-tuning the whole network, we freeze it during the fine-tuning process and add a few parameters that are trained to adapt the original model to the new data.

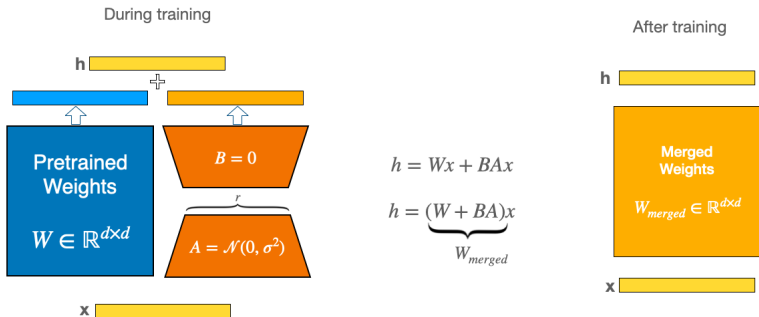

LoRA

- Let $W_0 \in \mathbb{R}^{d \times k}$ be the weight matrix of the pre-trained network.
- LoRA uses two adjustable low-rank decomposition matrices of predefined rank r , $B \in \mathbb{R}^{d \times r}$ and $A \in \mathbb{R}^{r \times k}$.
- The resulting fine-tuned network W_L is obtained as follows:

$$W_L = W_0 + \Delta W = W_0 + BA, \quad B \in \mathbb{R}^{d \times r}, \quad A \in \mathbb{R}^{r \times k} \quad (1)$$

- During training, W_0 remains frozen, and only B and A receive gradient updates.
- The lower the value of r , the fewer parameters will be trained during fine-tuning (there is a trade-off between performance and computation costs).

QLoRA

- QLoRA is an even more memory efficient version of LoRA where the pretrained model is loaded to GPU memory as **quantized** 4-bit weights.
- The quantized LLM is then finetuned using LoRA.
- The LoRA adapter weights will be FP32, as all of the training will happen on these weights.
- Once all the training is done, the original weights will be de-quantized.
- QLoRA reduces the average memory requirements of finetuning a 65B parameter model from $> 780GB$ of GPU memory to $< 48GB$.

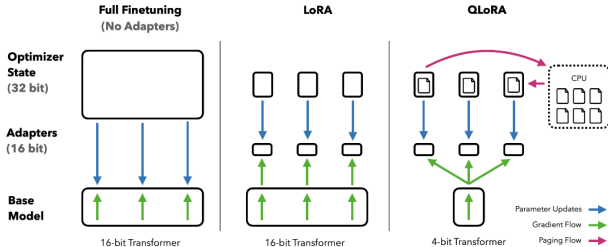

Quantization

- Quantization: Process of discretizing input from high-bit representation to low-bit representation.
- To ensure that the entire range of the low-bit data type is used, the input data type is commonly rescaled into the target data type range through normalization by the absolute maximum of the input elements.
- Example: quantizing a 32-bit Floating Point (FP32) tensor into a Int8 tensor with range $[-127, 127]$:

$$X_{\text{Int8}} = \text{round}_{\text{digits}(0)} \left(\frac{127}{\text{absmax}(X_{\text{FP32}})} \cdot X_{\text{FP32}} \right) = \text{round}_{\text{digits}(0)} (c_{\text{FP32}} \cdot X_{\text{FP32}})$$

where c is the quantization constant or quantization scale.

- Dequantization:

$$\text{dequant}(c_{\text{FP32}}, X_{\text{Int8}}) = \frac{X_{\text{Int8}}}{c_{\text{FP32}}} = X_{\text{FP32}}$$

Quantization

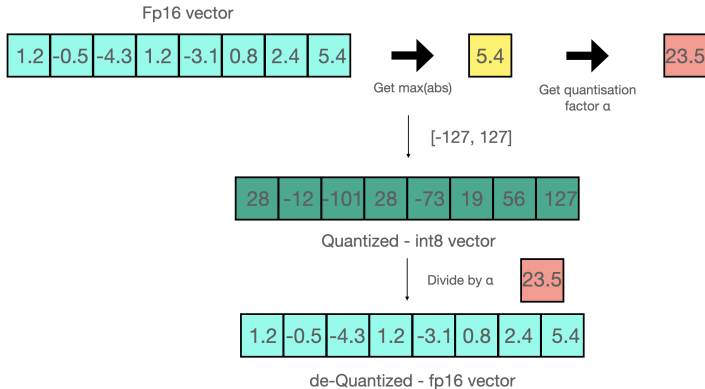

source: <https://huggingface.co/blog/hf-bitsandbytes-integration>

QLoRA main Ideas

- 4-bit NormalFloat, an information theoretically optimal quantization data type for normally distributed data¹ that yields better empirical results than 4-bit Integers and 4-bit Floats.
- Double Quantization, a method that quantizes the quantization constants, saving an average of about 0.37 bits per parameter (approximately 3 GB for a 65B model).
- Paged Optimizers help prevent memory spikes when dealing with long sequences by using NVIDIA unified memory. This enables smooth transfers between GPU and CPU when the GPU is low on memory.

¹pretrained neural network weights usually have a zero-centered normal distribution with standard deviation σ

Usage Pattern 3: Applications

- LLMs are widely embedded in software through API calls.
- Why? Because LLM's apart from generating text cannot perform other type of actions.
- Example: search engines (`you.com`), Bing chat.
- For example, PDF summarization software. You write software that first converts the PDF to raw text and then sends it to an LLM for summarization.
- Or software for summarizing video conferences. First the audio is transcribed and then summarized with an LLM.
- From a software point of view, this isn't much different from any software that interacts with an external API.
- ChatGPT Plugins: <https://gptstore.ai/>

Usage Pattern 3: Applications

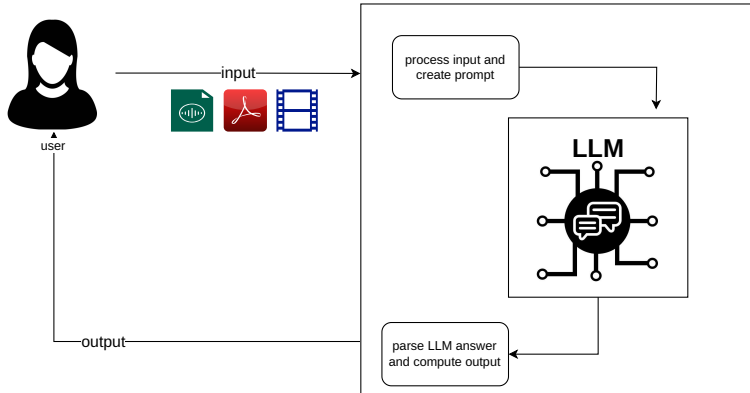

Usage Pattern 3.1: Autonomous Agents

- Autonomous agents lie at the heart of classical AI.
- Agents are programs that interact autonomously with an environment and perform actions to achieve specific goals.
- The ReaAct (Reasoning and Acting) pattern [Yao et al., 2022] is a framework in which LLMs are used to generate both reasoning traces and task-specific actions in an interleaved manner for agents.
- Agents are a special kind of LLMs application in which the LLM serves as the reasoning and planning component of the software.
- LangChain is a very popular python Library for implementing LLM-based agents.



General setup of an agent

- Consider a general setup of an agent interacting with an environment to solve a task.
- There are several discrete time steps t_0, t_1, \dots, t_n .
- There is a set of all possible states or observations O received from the environment.
- There is a set of actions A that the agent can take.
- At each time step t , the agent receives an observation $o_t \in O$ and takes the action $a_t \in A$ following a policy $\pi(a_t|c_t)$ where context $c_t = (o_1, a_1, \dots, o_{t-1}, a_{t-1}, o_t)$.
- Learning a policy is challenging when the mapping $c_t \mapsto a_t$ is highly implicit and requires extensive computation.

General setup of an agent

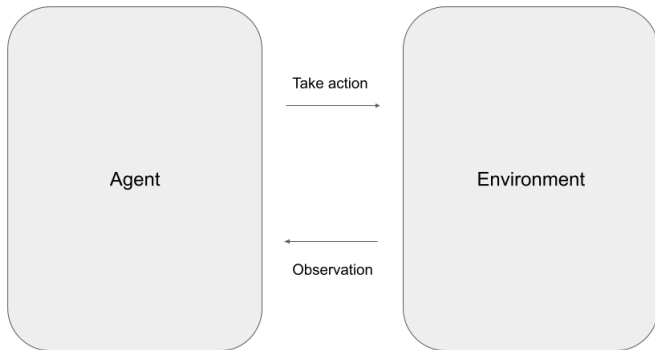

Source: <https://leftasexercise.com/2023/06/17/autonomous-agents-and-llms-autogpt-langchain-and-all-that/>

ReAct: Synergizing Reasoning + Acting

- In the ReAct framework, we expand the agent's action space by incorporating a Language Model (LLM), denoted as $A' = A \cup L$ (with L representing the language space).
- The environment is conceptualized as a toolkit, consisting of diverse interfaces that the agent can leverage.
- These interfaces take various forms, including API calls and Python functions (such as a search engine, calculator, or web scraper).
- At each step, the agent consults the LLM (using chain of thought prompting) to determine its next action, considering the available tools.

ReAct: Synergizing Reasoning + Acting

- This action, denoted as $a'_t \in L$ within the language space, is termed a “thought”.
- The context is dynamically updated as $c_{t+1} = (c_t, a'_t)$ for subsequent reasoning or action.
- The agent then executes one of the available tools to perform the action, incorporating the result as a new observation in the next prompt sent to the model.
- This iterative process continues until the task is successfully solved.
- Problem: if the model starts to hallucinate or to repeat itself, we can easily follow a trajectory of actions that takes us nowhere or end up in a loop.

ReAct Agents

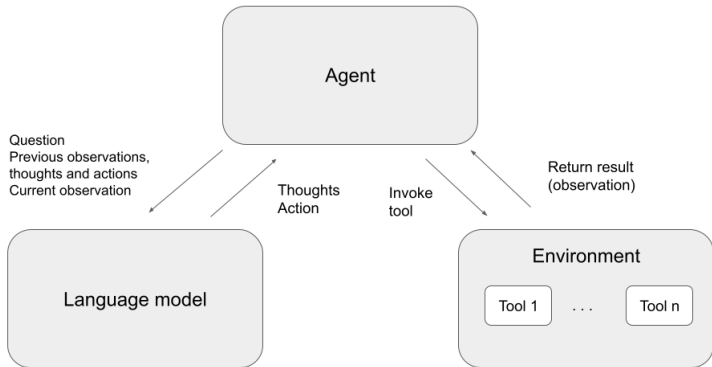

Source: <https://leftasexercise.com/2023/06/17/autonomous-agents-and-llms-autogpt-langchain-and-all-that/>

LangChain Example

```
from langchain.agents import AgentExecutor
```

```
agent_executor = AgentExecutor(agent=agent, tools=tools, verbose=True)
```

```
agent_executor.invoke(  
    {  
        "input": "Who is Leo DiCaprio's girlfriend? What is her current age raised to the 0.43 power?"  
    }  
)
```

```
> Entering new AgentExecutor chain...  
I need to find out who Leo DiCaprio's girlfriend is and then calculate her age raised to the 0.43 power  
Action: Search  
Action Input: "Leo DiCaprio girlfriend"model Vittoria Ceretti I need to find out Vittoria Ceretti's age  
Action: Search  
Action Input: "Vittoria Ceretti age"25 years I need to calculate 25 raised to the 0.43 power  
Action: Calculator  
Action Input: 25^0.43Answer: 3.991298452658078 I now know the final answer  
Final Answer: Leo DiCaprio's girlfriend is Vittoria Ceretti and her current age raised to the 0.43 power  
  
> Finished chain.
```

```
{'input': "Who is Leo DiCaprio's girlfriend? What is her current age raised to the 0.43 power?",  
 'output': "Leo DiCaprio's girlfriend is Vittoria Ceretti and her current age raised to the 0.43 power :
```

Evaluation Pattern 1: Multi-task benchmarks

- How are standard single-task NLP systems typically evaluated?
- There is a gold standard evaluation dataset that is not used during training, on which predictions can be compared against gold labels using task specific metrics (e.g., F1, BLEU).
- When first-generation LLMS (e.g., BERT) were developed, the idea of multi-task evaluation took on greater importance.
- Multi-task benchmarks such as GLUE and SuperGlue emerged from this perspective.
- Classic NLP tasks included: classification, question answering, word sense disambiguation, etc.
- These benchmarks are still designed for a fine-tuning supervised-learning setting.



Evaluation Pattern 2: World-knowledge benchmarks

- A second generation of benchmarks later emerged for tasks involving science, reasoning, multitasking accuracy, and truthfulness.
- To attain high accuracy on this test, models must possess extensive world knowledge and problem solving ability.
- They typically require LLMs to generate a short, specific answer to close-ended problems that can be automatically validated (e.g., multiple-choice questions).
- Two main categories: knowledge-based and reasoning-based benchmarks.
- Examples: AI2 Reasoning Challenge (25-shot), MMLU (5-shot), TruthfulQA (0-shot), and HellaSwag (10-shot).

Microeconomics

One of the reasons that the government discourages and regulates monopolies is that

- (A) producer surplus is lost and consumer surplus is gained.
- (B) monopoly prices ensure productive efficiency but cost society allocative efficiency.
- (C) monopoly firms do not engage in significant research and development.
- (D) consumer surplus is lost with higher prices and lower levels of output.



Figure 3: Examples from the Microeconomics task.

Evaluation Pattern 2: World-knowledge benchmarks

Most of these benchmarks are combined in the HuggingFace Open LLM Leaderboard:

https://huggingface.co/spaces/HuggingFaceH4/open_llm_leaderboard

LLM Benchmark Metrics through time About Submit here!

Search for your model (separate multiple queries with `;`) and press ENTER...

Select columns to show

Average ARC HellaSwag MMLU TruthfulQA
 Winogrande GSM8K Type Architecture Precision
 Hub License #Params (B) Hub Available on the hub
 Model sha

Show gated/private/deleted models

Model types

pretrained fine-tuned Instruction-tuned RL-tuned
 ?

Precision

float16 bfloat16 8bit 4bit GPTQ ?

Model sizes (in billions of parameters)

? ~1.5 ~3 ~7 ~13 ~35 ~60
 70+

T	Model1	Average	ARC	HellaSwag	MMLU	TruthfulQA	Winogrande	GSM8K
◆	fblgit/una-xabarius-34b-v1beta	74.18	70.39	86.77	78.15	61.45	84.93	63.38
◆	ValiantLabs/ShiningValiant	73.78	71.33	90.96	71.21	70.29	84.21	54.66
◆	sequelbox/SunsetBoulevard	73.78	71.33	90.96	71.21	70.29	84.21	54.66
●	Qwen/Qwen-72B	73.6	65.19	85.94	77.37	60.19	82.48	70.43
○	SUSTech/SUS-Chat-34B	73.22	66.3	83.91	76.41	57.04	83.5	72.18
◆	AIDC-ai-business/Marcoroni-7B-v3	72.53	69.45	86.78	65	60.4	81.45	72.1
◆	OpenBuddy/openbuddy-deepseek-67b-v15.2	72.33	68.6	86.37	71.5	56.2	84.45	66.87

Evaluation Pattern 3: Multi-turn benchmarks

- Modern LLMs, in addition to being multi-task models, assist users in multi-turn open-ended dialogues.
- This ability cannot be evaluated by the above benchmarks because there isn't always a clear correct answer.
- MT Bench: 80 high-quality multi-turn questions in 8 categories: Writing, Role Play, Extraction, Reasoning, Math, Coding, Knowledge I (STEM), and Knowledge II (Humanities/Social Sciences).

Biological Science

Question: Share ideas for adapting art masterpieces into interactive experiences for children. List 5 specific artworks and associated ideas.

Assistant A:

Sure, here are five ideas for adapting art masterpieces into interactive experiences for children:

1. "The Starry Night" by Vincent van Gogh - Create a virtual reality experience where children can explore the night sky and see the stars and constellations as van Gogh saw them. They can also create their own starry night scenes using different colors and brush strokes.

2. "The Persistence of Memory" by Salvador Dali - Create a sensory experience where children can touch, feel, and smell different objects to explore the surrealist themes of Dali's painting. They can also create their own surreal landscapes using different materials and textures.

3. ...

(omitted)

Follow-up Question: Write a concrete plan for your second example. Include budget estimates.

Assistant A:

Sure, here is a concrete plan for adapting "The Persistence of Memory" by Salvador Dali into an interactive experience for children:

1. Budget: \$5,000

2. Objectives:

- To create a sensory experience that allows children to explore the surrealist themes of Dali's painting.

- To encourage children to create their own surreal landscapes using different materials and textures.

...

Evaluation Pattern 3: Multi-turn benchmarks

- Limitation of multi-turn evaluation: needs to be evaluated by humans which is expensive to evaluate.
- Chatbot Arena: a crowdsourcing platform that allows users to engage in conversations with two anonymous chat LLMs and report pairwise comparison results.

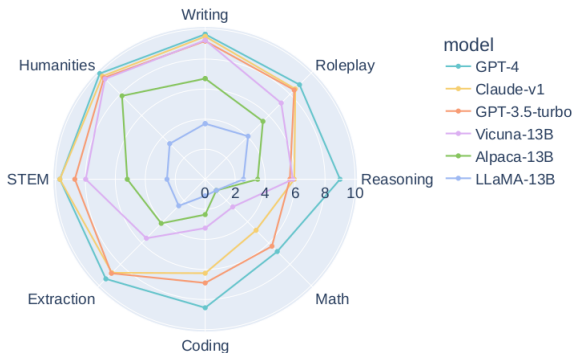

Evaluation Pattern 4: LLM-as-a-judge

- LLM-as-a-judge: use a state-of-the-art LLM (e.g., GPT-4) to evaluate other LLMs.
- Results reveal that GPT-4 can match both controlled and crowdsourced human preferences well achieving over 80% agreement, the same level of agreement between humans.

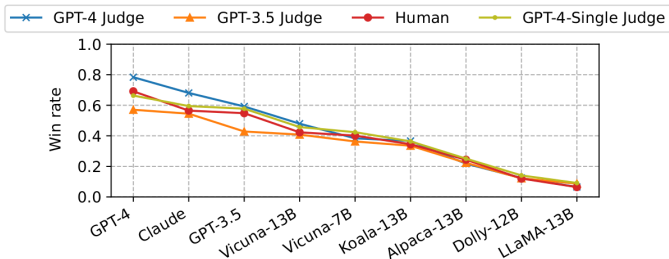

LLM Evaluation Approaches

Method	Evaluation	Model Types	Abilities/Domain	Data Source
Benchmark	MMLU 364	Base/Fine-tuned/Specialized	General	Human exam/practice
	BIG-bench 70	Base/Fine-tuned/Specialized	General	Human annotation
	HELM 520	Base/Fine-tuned/Specialized	General	Benchmark collection
	Open LLM Leaderboard 707	Base/Fine-tuned/Specialized	General	Benchmark collection
	AGIEval 708	Base/Fine-tuned/Specialized	General	Human exam/practice
	MMCU 709	Base/Fine-tuned/Specialized	General	Human exam/practice
	M3KE 710	Base/Fine-tuned/Specialized	General	Human exam/practice
	C-Eval 711	Base/Fine-tuned/Specialized	General	Human exam/practice
	Xiezhi 712	Base/Fine-tuned/Specialized	General	Human exam/practice
	OpenCompass 713	Base/Fine-tuned/Specialized	General	Benchmark collection
	Chain-of-Thought Hub 714	Base/Fine-tuned	General	Benchmark collection
	KoLA 715	Base/Fine-tuned	Knowledge utilization	Web
	ARB 716	Fine-tuned	Complex reasoning	Human exam/practice
	APIBench 717	Base/Fine-tuned	Tool manipulation	Web
	APIBank 718	Fine-tuned	Tool manipulation	Synthesis
	ToolAlpaca 719	Base/Fine-tuned	Tool manipulation	Synthesis
	T-Bench 720	Fine-tuned	Tool manipulation	Synthesis
	ToolBench 721	Fine-tuned	Tool manipulation	Synthesis
	BOLAA 722	Base/Fine-tuned	Environment interaction	Benchmark collection
	AgentBench 723	Base/Fine-tuned	Environment interaction	Human annotation/Synthesis
HaluEval 602	Base/Fine-tuned	Human alignment	Human annotation/Synthesis	
PromptBench 724	Base/Fine-tuned	Robustness	Benchmark collection	
HumanEval 105	Base/Fine-tuned/Specialized	Code synthesis	Human annotation	
MultiMedQA 356	Specialized	Healthcare	Benchmark collection	
FLUE 725	Specialized	Finance	Benchmark collection	
LegalBench 726	Specialized	Legal	Human annotation	
Human	Chatbot Arena 727	Base/Fine-tuned/Specialized	Human Alignment	Human annotation
	SciBench 728	Fine-tuned	Complex reasoning	Human exam/practice
Model	AlpacaEval 729	Fine-tuned	Instruction following	Synthesis
	MT-bench 727	Fine-tuned	Human alignment	Human annotation
	TrustGPT 730	Base/Fine-tuned	Human alignment	Benchmark collection
	LMExamQA 731	Base/Fine-tuned	Knowledge utilization	Synthesis
	ChatEval 732	Base/Fine-tuned	Knowledge utilization	Benchmark collection

Conclusions

- We visited several emerging patterns of use and evaluation of LLMs.
- LLMs are not an isolated technology, but interact with many other disciplines: Information Retrieval, Autonomous Agents, Software Engineering.
- Their reasoning and planning capabilities, despite their limitations, have the potential to impact more general areas of AI (beyond NLP).
- The open-ended aspect of this technology challenges standard NLP evaluation approaches.

Questions?

Thanks for your Attention!

References I



Chung, H. W., Hou, L., Longpre, S., Zoph, B., Tay, Y., Fedus, W., Li, Y., Wang, X., Dehghani, M., Brahma, S., Webson, A., Gu, S. S., Dai, Z., Suzgun, M., Chen, X., Chowdhery, A., Castro-Ros, A., Pellat, M., Robinson, K., Valter, D., Narang, S., Mishra, G., Yu, A., Zhao, V., Huang, Y., Dai, A., Yu, H., Petrov, S., Chi, E. H., Dean, J., Devlin, J., Roberts, A., Zhou, D., Le, Q. V., and Wei, J. (2022).
Scaling instruction-finetuned language models.



Dettmers, T., Pagnoni, A., Holtzman, A., and Zettlemoyer, L. (2023).
Qlora: Efficient finetuning of quantized llms.
arXiv preprint arXiv:2305.14314.



Hu, E. J., Shen, Y., Wallis, P., Allen-Zhu, Z., Li, Y., Wang, S., Wang, L., and Chen, W. (2021).
Lora: Low-rank adaptation of large language models.
arXiv preprint arXiv:2106.09685.



Lewis, P., Perez, E., Piktus, A., Petroni, F., Karpukhin, V., Goyal, N., Küttler, H., Lewis, M., tau Yih, W., Rocktäschel, T., Riedel, S., and Kiela, D. (2021).
Retrieval-augmented generation for knowledge-intensive nlp tasks.



Ouyang, L., Wu, J., Jiang, X., Almeida, D., Wainwright, C., Mishkin, P., Zhang, C., Agarwal, S., Slama, K., Ray, A., et al. (2022).
Training language models to follow instructions with human feedback.
Advances in Neural Information Processing Systems, 35:27730–27744.

References II



Wei, J., Wang, X., Schuurmans, D., Bosma, M., Chi, E., Le, Q., and Zhou, D. (2022).

Chain of thought prompting elicits reasoning in large language models.
arXiv preprint arXiv:2201.11903.



Yao, S., Zhao, J., Yu, D., Du, N., Shafran, I., Narasimhan, K. R., and Cao, Y. (2022).

React: Synergizing reasoning and acting in language models.
In The Eleventh International Conference on Learning Representations.



Zhao, W. X., Zhou, K., Li, J., Tang, T., Wang, X., Hou, Y., Min, Y., Zhang, B., Zhang, J., Dong, Z., Du, Y., Yang, C., Chen, Y., Chen, Z., Jiang, J., Ren, R., Li, Y., Tang, X., Liu, Z., Liu, P., Nie, J.-Y., and Wen, J.-R. (2023).

A survey of large language models.